



Model: **M30**
Owner's Operation Manual

For correct operation, please read this manual to
familiarise yourself with the features.

Includes wiring diagram
We recommend professional installation of this security product.

Imported and distributed by Mongoose (Australia) PTY Limited

M30 REMOTE SECURITY KEY

BUTTON ONE

'ARM'
PRESS FOR 0.5 SECONDS
TO ARM THE SECURITY SYSTEM -
(DOORS WILL ALSO LOCK IF THE
CENTRAL LOCKING HAS BEEN
CONNECTED)

SENSOR DISABLE
PRESS BUTTON ONE WITHIN 5
SECONDS OF ARMING TO BYPASS
THE SHOCK SENSOR

BUTTON THREE

SILENT ARM
PRESS TO SILENTLY ARM THE
SYSTEM WITHOUT SIREN CHIRPS.
DISARM IS AUTOMATICALLY SILENT

**PRESS ANY BUTTON TO
CANCEL ALARM SOUNDING**



BUTTON TWO

'DISARM'
PRESS DISARM THE ALARM SYSTEM.
(DOORS WILL ALSO UNLOCK IF THE
CENTRAL LOCKING HAS BEEN
CONNECTED)

BOOT RELEASE (CH'2 OUTPUT)
PRESS FOR 2 SECONDS FOR CHANNEL 2
OUTPUT. IE; BOOT RELEASE (OPTIONAL
FITTING)

BUTTON FOUR

'PANIC'
PRESS FOR AT LEAST 2 SECONDS TO
SOUND THE SIREN AND FLASH THE
INDICATORS

'CAR LOCATOR'

LED

THE LED CONFIRMS REMOTE TRANSMISSION.
RCB27A Battery

REMOTE MAY DIFFER
TO THAT SHOWN

CONTENTS

Operating your security system.....	4	Anti-hijack.....	7
Remote control key.....	4	Arm condition memory.....	7
Arming and disarming.....	4	Chirp confirmation codes.....	7
Arming reminder.....	4	Dash mounted warning light (LED)...	7
Silent arming.....	4	Emergency override.....	8
Engine immobiliser.....	5	Valet mode.....	8
Central locking.....	5	Security auto re-arm.....	8
Automatic, last door, arming.....	5	Ignition safety door lock.....	8
Doors, bonnet & boot.....	5	Temporary parking.....	8
Defective zone bypass.....	6	Window wind-up.....	9
Impact sensor & bypass.....	6	Remote code learning.....	9
Smart arming delay.....	6	Wiring diagrams	
Panic.....	6	Warranty terms and conditions	
		Proof of purchase	

OPERATING YOUR VEHICLE SECURITY SYSTEM

REMOTE CONTROLS - 4 BUTTON x 2

Two 4 button remote control keys are supplied with the system which enable you to arm and disarm your security system. One remote control should be kept with your car keys and the other with your spare car keys in a safe place.

ARMING

Before arming the system, turn the engine off and remove the keys from the ignition. Ensure all windows, doors, bonnet and boot are closed.

The system is armed by depressing the **LOCK** remote button momentarily (0.5 seconds). It is important to press the button for the recommended time as a shorter duration may not activate the system. Verify that the LED on the remote illuminates. If it does not light, the battery may need changing.

You will notice the indicators flash once and the siren chirps once to indicate that the system is armed. The dash mounted warning light, LED, will slow flash after 7 seconds to indicate armed mode.

If your vehicle has central locking, and it has been connected to this security system, the doors will lock at the same time as arming.

ARMING REMINDER

If the alarm is not armed within 10 seconds of closing the last door, the alarm will remind you by chirping the siren 3 times with lights flashing. (This feature cannot be programmed off)

If 'last door arming' is programmed ON, the alarm will automatically arm after 60 seconds. The doors will not lock to prevent keys being locked inside. (See 'last door arming')

DISARMING

Press the **UNLOCK** remote control button to disarm the system. The siren will chirp twice and the indicators will flash twice. The doors will unlock if this system has been connected to the vehicles central locking system.

SILENT ARMING

Press  to silently arm the system without the siren chirps – lights still flash.

When silently armed, the shock sensor is bypassed. Disarming is automatically silent.

ENGINE IMMOBILISER

This security system is equipped with an engine immobiliser to prevent engine starting when the system is armed. The authorised installer of this product should have advised you which circuit has been immobilised. If you require the anti-hijack feature either the ignition or electric fuel pump should be immobilised.

CENTRAL LOCKING - KEYLESS ENTRY*

This security system has built-in relays to control central locking systems. The system is programmable to operate standard electric or vacuum systems.

* Certain vehicles may require additional parts to enable the correct use of this feature. These parts are not included in this system. Kits are available to convert vehicles with manual door locks to electric operation.

AUTOMATIC - LAST DOOR ARMING (PROGRAMMABLE – OFF as default)

The system can be programmed to arm automatically 60 seconds after closing the last door (or bonnet or boot).

Opening a door within this time will suspend the countdown and recommence on door closure.

To turn on 'last door arming': With ignition ON, press **LOCK** for 2 seconds. Confirmed by one chirp and light flash.

To turn off 'last door arming': Repeat above. Confirmed by two chirps and light flashes.

DOORS, BONNET AND BOOT PROTECTION

The siren will sound and the indicators will flash for 25 seconds should any of these be opened when the system is armed.

Note: The system requires your vehicle to be fitted with courtesy door light switches. Fitting door switches will incur extra costs if not standard in your vehicle.

DEFECTIVE ZONE BYPASS

If any door, the bonnet or boot has been left open when arming, the siren will chirp 3 times as a warning. The open circuit will then be bypassed if not closed and arm after 10 seconds.

An intrusion via a bypassed circuit will not trigger the alarm.

IMPACT SENSOR - 2 STAGE

The sensor is designed to detect vibrations such as an impact, vehicle towing causing shock, or glass breakage caused by hitting. It may also be triggered by shock waves produced from loud exhausts, thunder and heavy vehicle traffic. It is not normally triggered by normal wind or rocking motions. If the sensor receives a light impact the siren fast chirps for a few seconds. It sounds fully for 15 seconds if it detects a heavier impact.

The sensitivity level is set by the installer and should be at its optimum. Over sensitivity can cause false alarms. ***A trigger of the shock sensor will not sound the siren if it has been bypassed by the remote.***

SHOCK SENSOR BYPASS

The shock sensor can be bypassed to prevent false alarms. Arm the system by pressing **LOCK** and within 5 seconds press **LOCK** again. The siren will chirp 5 times to confirm the sensor is bypassed.

SMART ARMING DELAY

When arming, if the shock sensor is detecting shock or impact – such as detecting the door being slammed, the system will delay arming until the sensor is inactive to prevent a false alarm. However, the immobiliser is instantly active.

AUTOMATIC RE-SET

The siren will sound for 5 to 30 seconds, depending on the circuit triggered, after which it will stop and reset to the armed position. It will then re-trigger on the next intrusion or if a circuit was left open.

PANIC

In the event of personal attack, the alarm can be 'panicked' for 15 seconds by pressing the **RED** button for more than 2 seconds. Press any button to cancel.

ANTI-HIJACK (default is OFF)

In the event of an attempted vehicle theft whilst driving, press **X** for 2 seconds to activate anti-hijack. The siren will sound periodically and the lights will flash until **UNLOCK** is pressed to cancel. This will also immobilise the engine if programmed on.

To turn engine kill on: Press **UNLOCK** and **X** for 2s with ignition on. One chirp confirms

To turn engine kill off: Repeat above. Two chirps confirm

ARM CONDITION MEMORY

Should the vehicle battery be disconnected, the system memorises the last set position of the alarm. If the alarm was disarmed, reconnection does not cause the alarm to sound. If the battery was disconnected whilst armed, reconnection will cause the system to trigger. To cancel, disarm with the remote control.

ALARM CHIRP CONFIRMATION CODES

This is an audible indication of system status.

- A) 1 Chirp - Armed
- B) 2 Chirps - Disarmed
- C) 2 Chirps, then 1 chirp after door open – Disarmed and indicates the alarm has been triggered
- D) 3 Chirps – Arming reminder or light impact of shock sensor
- E) Chirps for 15 seconds – Heavy impact of shock sensor or 'panic'

DASH MOUNTED WARNING LIGHT - LIGHT EMITTING DIODE (LED)

The dash mounted LED shows the status of the alarm;

- A) Twice then pause - System armed
- B) Three times then pause - Alarm triggered by impact
- B) ON for 2 sec's then pause - Alarm triggered by doors, bonnet or boot.
- C) LED off - System off
- D) Continuously lit - Valet mode

EMERGENCY OVERRIDE - Ensure you know the location of the emergency switch.

At the time of installation, a hidden push button switch was fitted under the dashboard.

If the alarm fails to respond to the remote control, or you have misplaced it, you can override the alarm as follows;

- 1) Open the door with the ignition key - the siren will sound and the indicators will flash & turn the ignition on
- 2) Press the override push button for 2 seconds - this will cancel the alarm sounding and override the system.

VALET MODE

To turn on: Press and hold the override switch, then turn the ignition ON – system will enter valet mode after 5 seconds and confirmed by one siren chirp. LED will stay lit to indicate valet mode.

To turn off: Repeat to turn the alarm system back on which is confirmed by two siren chirps. LED will go out.

SECURITY RE-ARM (& RE-LOCK)

The alarm will automatically re-arm if it has been disarmed by remote but the doors have not been opened within 25 seconds. Doors also re-lock if central locking connected.

(This feature may not be operative if your vehicle has interior dome light delay)

IGNITION SAFETY DOOR LOCK - PROGRAMMABLE

When connected to a vehicle with central locking, the doors will lock 20 seconds after ignition 'on' and unlock with ignition 'off'. If a door is left open during engine starting, the safety door lock feature will be inoperative when the door is closed.

Press LOCK & UNLOCK at same time with ignition ON to turn feature on (1 chirp) or off (2 chirps).

TEMPORARY PARKING WARNING (default is ON)

If you wish to temporarily park with the engine running, opening a door will cause the lights to flash to warn other vehicles that someone is exiting your vehicle.

To turn warning on: Press **LOCK** button and  at the same time for 2 seconds. 1 chirp confirms

To turn warning off: Repeat above. 2 chirps confirm

WINDOW WIND-UP

This security system has the ability to automatically close all vehicle electric windows when the alarm is armed. Extra parts at additional cost may be required to enable this feature.

ELECTRONIC SIREN

If washing the engine bay, cover the siren with a plastic bag to prevent damage. Heat or water damage is not covered by the warranty.

REMOTE CODE LEARNING

If you wish to add further remotes, or a remote has to be replaced, the new remote needs to be learnt into the alarm system.

If a remote is lost and are fearful that someone may try to use it, the lost remote can be deleted from memory – just learn the remaining remote – the lost one is then deleted from memory.

NOTE: An irregular or interruption to the vehicles power supply, such as battery jump starting, can cause loss of remote memory. If your alarm fails to respond to the remote try re-learning them.

TO MEMORISE A NEW REMOTE:

- a) Disarm the system by remote or the override method.
- b) Open the door and press and hold the override switch.
- c) Turn the ignition off/on three times (leave ON 3rd time). Dash LED lights constantly to indicate learning mode.
- c) Press any button on the 1st remote. Dash LED will flash 3 times to confirm learning
- d) Press any button on the 2nd remote. Dash LED will flash 3 times to confirm learning.
- e) Turn the ignition OFF and release the override switch to complete the learning.

If no remote button is pressed within 10 sec's of entering learning mode, the system will exit.

This procedure can be repeated for up to 4 remotes.

Learning just one remote erases all previous. All existing remotes must be learnt at the same time.

WIRING INFORMATION: Installation to be carried out by suitably qualified persons.

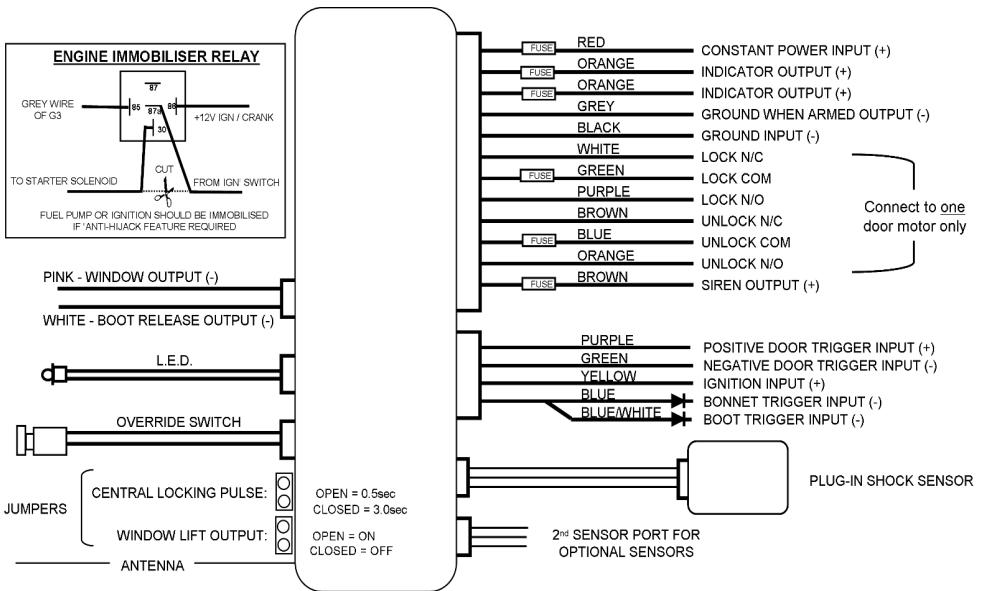

Examples of central locking connections

POSITIVE OR NEGATIVE SWITCHING

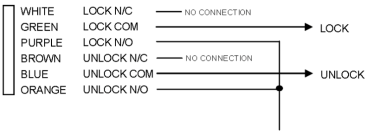

CONNECT TO GROUND FOR NEGATIVE SWITCHING
OR
TO 12V FOR POSITIVE SWITCHING (insert fuses if none supplied)

ADD ON DOOR MOTOR

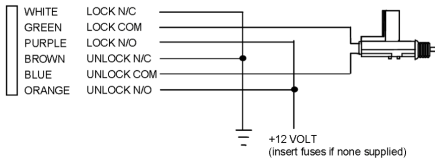

REVERSE POLARITY

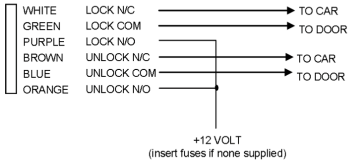

SINGLE WIRE SWITCHING

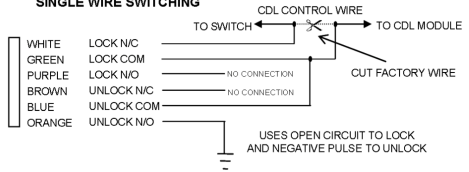

VACUUM PUMP SYSTEM

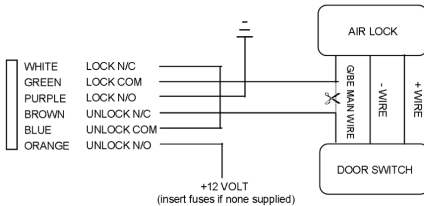

For air lock only.
Audi, Benz. The door wire
will switch (+) & (-) when
locking & unlocking

WARRANTY CONDITIONS

Mongoose warrants that it will make good without charge, by repair or replacement with a reasonable equivalent, at Mongoose's discretion, any defect in the product, **excluding defect in installation**, submitted for claim for a period of three years from date of sale provided that:

- (a) the defect has been notified to an authorised Mongoose installation centre, distributor or agent (in the first instance to the original installation centre).
- (b) the alarm is less than 3 years of age from the date of sale and was manufactured within the last 4 years.
- (c) the alarm has been installed according to our written instructions
- (d) provision of proof of purchase and warranty registration on request.
- (e) an authorised installation centre has determined that the defect complained of is one of workmanship and not caused by;
 - (i) misuse or abuse such as misdirected current, water or fluid damage
 - (ii) operation of alarm after it is known to be defective
 - (iii) accident or deliberate act
 - (iv) alteration or modification of the alarm, or its components, by any party not authorised by Mongoose
 - (v) the fitting of parts or accessories not supplied or approved of by Mongoose
 - (vi) any work carried out on the alarm by someone other than an authorised Mongoose installation centre
 - (vii) any consequential damage
 - (viii) **if the alarm is installed by anyone other than an approved installer a limited parts only 12 month warranty applies**

Warranty for the installation is borne by the original installing agent only. This will be chargeable if not returned to the original installer.

Whilst every care is taken by our installers in fitting the alarm, Mongoose takes no responsibility for any damage caused to a vehicle in the installation process.

Responsibility is borne by the installer and any claims directed to them.

Exclusions from this warranty are;

- (i) alarms operated outside the original country of purchase
- (ii) batteries, i.e.; as fitted to the remote controls
- (iii) normal wear and tear
- (iv) transportation of repairs or replacement parts etc. to rectification centres
- (v) faults associated with the installation
- (vi) mobile service costs for repairs
- (vi) labour costs for repairs

THIS WARRANTY IS ONLY TRANSFERABLE AS SET OUT BELOW

If the vehicle is sold, the new owner receives the balance of the period between the original installation date and 3 years.

If the original owner has the system re-installed into an alternative vehicle by an authorised Mongoose installation centre, the owner receives the remaining period between the original installation date and 3 years.

Mongoose does not by inference, intent or any other means guarantee that a vehicle fitted with one of our security systems will not be stolen, broken into, tampered with, or parts taken. Vehicle security systems are deterrents and we recommend vehicle owners to have fully comprehensive insurance and to fit other security devices such as locking wheel nuts if the vehicle has expensive wheels and tyres.

PROOF OF PURCHASE
DO NOT LEAVE THIS INFORMATION IN THE VEHICLE

OWNERS NAME:..... VEHICLE MAKE:.....
ADDRESS:..... VEHICLE MODEL:.....
..... VEHICLE REG' NO:.....
TELEPHONE NO:..... ALARM MODEL NO:.....**M30**
ALARM PURCHASED FROM:.....
DATE PURCHASED:.....
INSTALLED BY:.....
DATE INSTALLED:.....
INSTALLER SIGNATURE:.....
OWNERS SIGNATURE:.....

Dealer

Please complete the above details, detach from this manual and keep in a safe place. These details should be presented to your Mongoose dealer in the unlikely event that you require this product to be repaired under the terms of the 'product warranty'. Refer 'Warranty Conditions'. Failure to provide this 'Proof of Purchase' may result in rectification charges being made. If you sell the vehicle within the warranty term, please pass this on to the new owner.



Mongoose (Australia) Pty Limited
Sydney, Brisbane
Mongoose (New Zealand) Limited
Auckland

For service contact your Mongoose agent;